

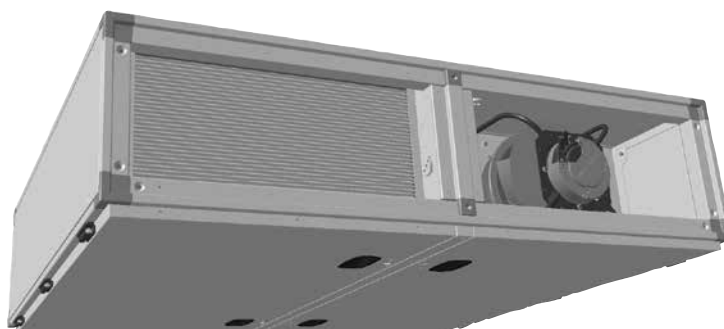





Schéma zapojenia vetracej jednotky

CFL-10 elektrický dohrievací register



0	1	2	3	4	5	6	7	8	9																																																																			
F26_001_Wolf_Standard																																																																												
		WOLF GmbH Industriestraße 1 D-84048 Mainburg Tel. +49 (0)8751 74-0																																																																										
<h1>Elektrická dokumentácia</h1>																																																																												
<table border="1" style="width: 100%; border-collapse: collapse;"> <tr> <td style="width: 30%;">jednotka</td> <td colspan="9">CFL10</td> </tr> <tr> <td></td> <td colspan="9">elektrický register, PKW</td> </tr> <tr> <td>kód výkresu</td> <td colspan="9">62-34-010-006</td> </tr> <tr> <td>Vytvoreno na</td> <td>03.04.2014</td> <td colspan="8"></td> </tr> <tr> <td>Editoval</td> <td>06.04.2017</td> <td>z (skratka)</td> <td>Kür</td> <td colspan="6">počet stránok</td> <td>15</td> </tr> </table>										jednotka	CFL10										elektrický register, PKW									kód výkresu	62-34-010-006									Vytvoreno na	03.04.2014									Editoval	06.04.2017	z (skratka)	Kür	počet stránok						15																
jednotka	CFL10																																																																											
	elektrický register, PKW																																																																											
kód výkresu	62-34-010-006																																																																											
Vytvoreno na	03.04.2014																																																																											
Editoval	06.04.2017	z (skratka)	Kür	počet stránok						15																																																																		
<table border="1" style="width: 100%; border-collapse: collapse;"> <tr> <td colspan="2"></td> <td>dátum</td> <td>06.04.2017</td> <td>jednotka</td> <td>CFL10</td> <td colspan="4">titulný / krycí list</td> </tr> <tr> <td colspan="2"></td> <td>sprac.</td> <td>Kür</td> <td></td> <td>elektrický register, PKW</td> <td colspan="4" rowspan="2" style="text-align: center;">  </td> </tr> <tr> <td colspan="2"></td> <td>preskúš.</td> <td></td> <td></td> <td></td> </tr> <tr> <td>zmena</td> <td>dátum</td> <td>meno</td> <td>62-34-010-006</td> <td>nahradený</td> <td>nahradený</td> <td colspan="4">62-34-010-006</td> </tr> <tr> <td colspan="2"></td> <td>pôvod</td> <td>62-34-010-006</td> <td></td> <td></td> <td>ODD: TR</td> <td>EPLAN P8 2.6.3</td> <td>Art.Nr. 3065200_SK</td> <td>=</td> <td>+</td> </tr> <tr> <td colspan="2"></td> <td></td> <td></td> <td></td> <td></td> <td colspan="2"></td> <td>lit</td> <td>1</td> </tr> <tr> <td colspan="2"></td> <td></td> <td></td> <td></td> <td></td> <td colspan="2"></td> <td>od</td> <td>15 listy</td> </tr> </table>												dátum	06.04.2017	jednotka	CFL10	titulný / krycí list						sprac.	Kür		elektrický register, PKW							preskúš.				zmena	dátum	meno	62-34-010-006	nahradený	nahradený	62-34-010-006						pôvod	62-34-010-006			ODD: TR	EPLAN P8 2.6.3	Art.Nr. 3065200_SK	=	+									lit	1									od	15 listy
		dátum	06.04.2017	jednotka	CFL10	titulný / krycí list																																																																						
		sprac.	Kür		elektrický register, PKW																																																																							
		preskúš.																																																																										
zmena	dátum	meno	62-34-010-006	nahradený	nahradený	62-34-010-006																																																																						
		pôvod	62-34-010-006			ODD: TR	EPLAN P8 2.6.3	Art.Nr. 3065200_SK	=	+																																																																		
								lit	1																																																																			
								od	15 listy																																																																			

0	1	2	3	4	5	6	7	8	9
farby kabeláže:									
hlavný prúdový okruh : čierny									
nulový vodič : biedomodrý									
ochranný vodič : žltozelený									
riadiaci okruh striedavého prúdu : červený/červenobiely									
riadiaci okruh jednosmerného prúdu : tmavomodrý/tmavomodrý/biely									
beznapäťový kontakt (cudzie napätie) : oranžový									
POZOR!									
Pred uvedením rozvádzača do prevádzky treba dodržať nasledovné:									
1. Všetky prípojky vyhotovte podľa miestnych predpisov dodávateľa energie									
2. U všetkých skrutiiek spojov a kontaktov ako aj neobsadených kontaktov sa musí skontrolovať riadne dotiahnutie (hrozí uvoľnenie pri transporte).									
3. Použitie ističe motorov EC ventilátorov a el. registrov sú využívané ako ističe vedenia, musia byť nastavené na menovitý prúd.									
4. Sieťové napätie porovnať s pripájacím napätím rozvádzača.									
5. Dĺžky vodičov snímačov/servomotorov, 24V-riadiacich vedení max. 50m Neukladať spolu s 230/400V vedeniami alebo použiť tienené káble									
6. Uvedené prierezy vedení sú minimálne prierezy medených vodičov bez zohľadnenia dĺžky káblov a stavebných daností. Typy káblov zvolte podľa spôsobu uloženia.									
7. Na zabezpečenie protimrazovej ochrany zariadenia sa hlavný vypínač Q1 nesmie vypnúť.									
8. Prúdové chrániče RCD Sú dovolené výlučne ako všeprúdové chrániče typu B s 300 mA.									
POKYNY NA UVEDENIE DO PREVÁDZKY									
									
jednotka CFL10 elektrický register, PKW									
nahradený nahradený									
dátum sprac. 05.04.2017									
presúš. Kur									
pôvod 62-34-010-006									
meno									
dátum									
=									
+									
Art.Nr. 3065200_SK									
EP/JAN P8 2.6.3									
62-34-010-006									
ODD: TR									
list 2									
od 15 listy									

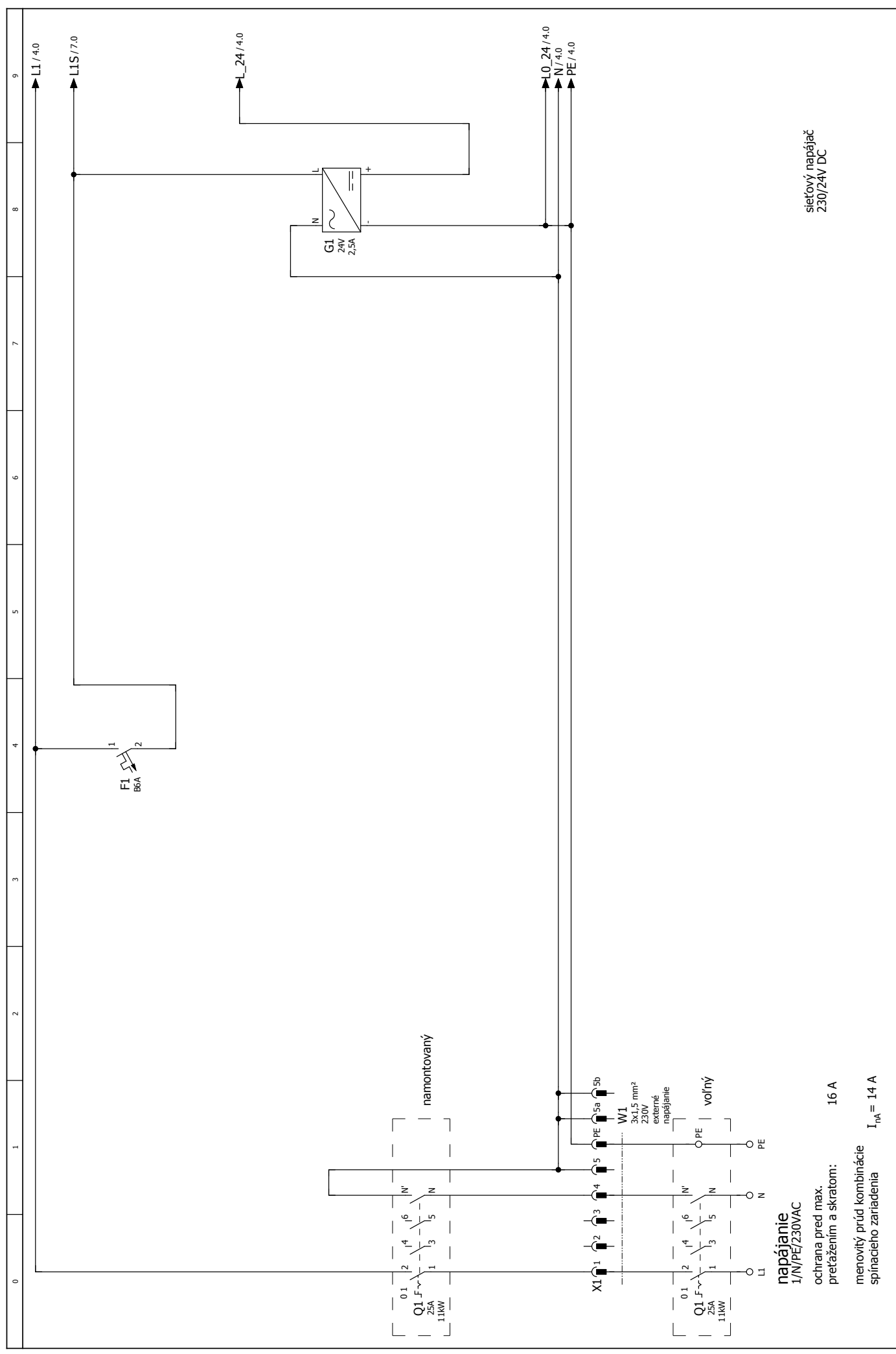

sietový napáječ
230/24V DC

napájanie
1/N/PE/230VAC

ochrana pred max.
preťažením a skratom: 16 A

menovitý prúd kombinácie
spínacieho zariadenia $I_{nA} = 14 A$

zmena	dátum	meno	pôvod	62-34-010-006	nahradený	jednotka	CFL10	elektrický register, PKW	NAPAJANIE HLAVNY VYPÍNAČ RJADIACE TRAFO	62-34-010-006	EPJAN P8 2.6.3	Art.Nr. 3065200_SK	lit od	3 15 listy



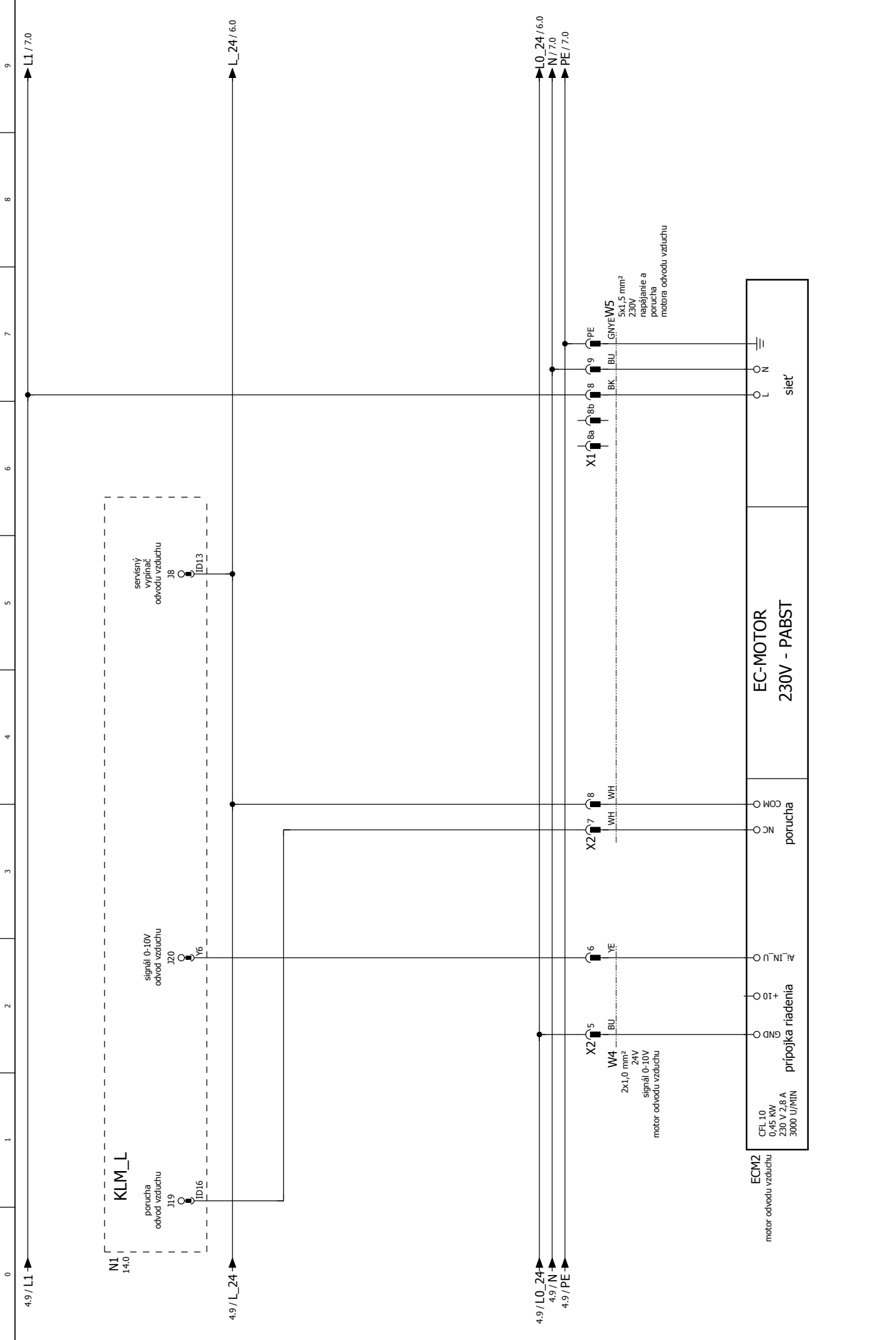

62-34-010-006		ODVODNÝ VENTILÁTOR	
EPLAN P8 2.6.3		Art.Nr. 3065200_SK	
=		+	
list	5	od	15 listy

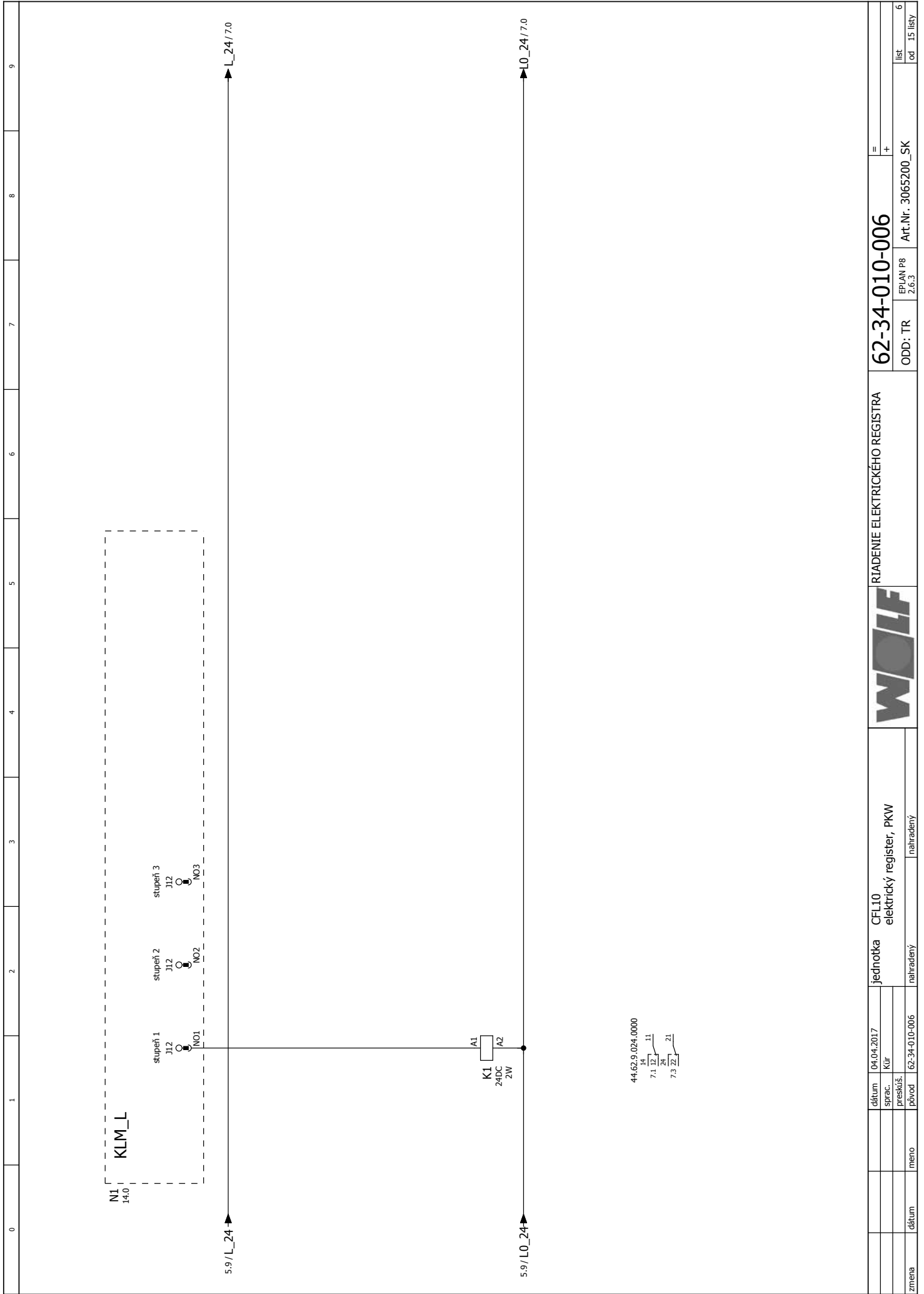

0	1	2	3	4	5	6	7	8	9
RIADENIE ELEKTRICKÉHO REGISTRA									
									
62-34-010-006									
jednotka CF110 elektrický register, PKW									
náhradný náhradný									
dátum 04.04.2017									
sprac. Kur									
preskuš.									
pôvod 62-34-010-006									
meno									
dátum									
= +									
ODD: TR									
EP/JAN P8 2.6.3									
Art.Nr. 3065200_SK									
list 6									
od 15 listy									

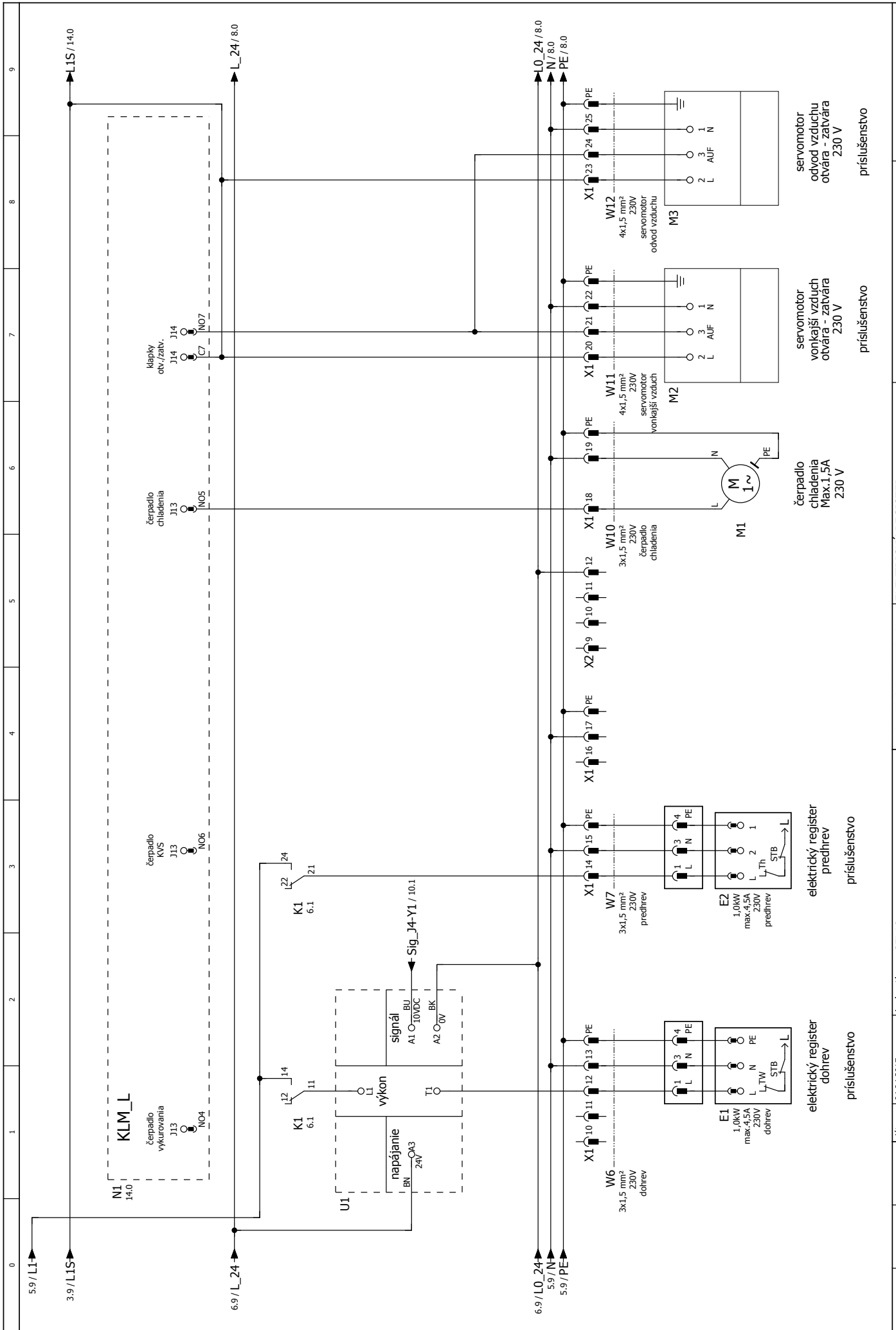

zmena		dátum	meno	preskúš.	skôr	dátum	04.04.2017	jednotka	CFL10	nahradený	nahradený	ELEKTRICKÝ REGISTER 230V SERVO MOTOR(Y) OTV.-ZATV.		62-34-010-006		EPLAN P8 2.6.3		Art.Nr. 3065200_SK		list	7
		dátum	meno	preskúš.	skôr	dátum	04.04.2017	jednotka	CFL10	nahradený	nahradený	ELEKTRICKÝ REGISTER 230V SERVO MOTOR(Y) OTV.-ZATV.		62-34-010-006		EPLAN P8 2.6.3		Art.Nr. 3065200_SK		od	15 listy



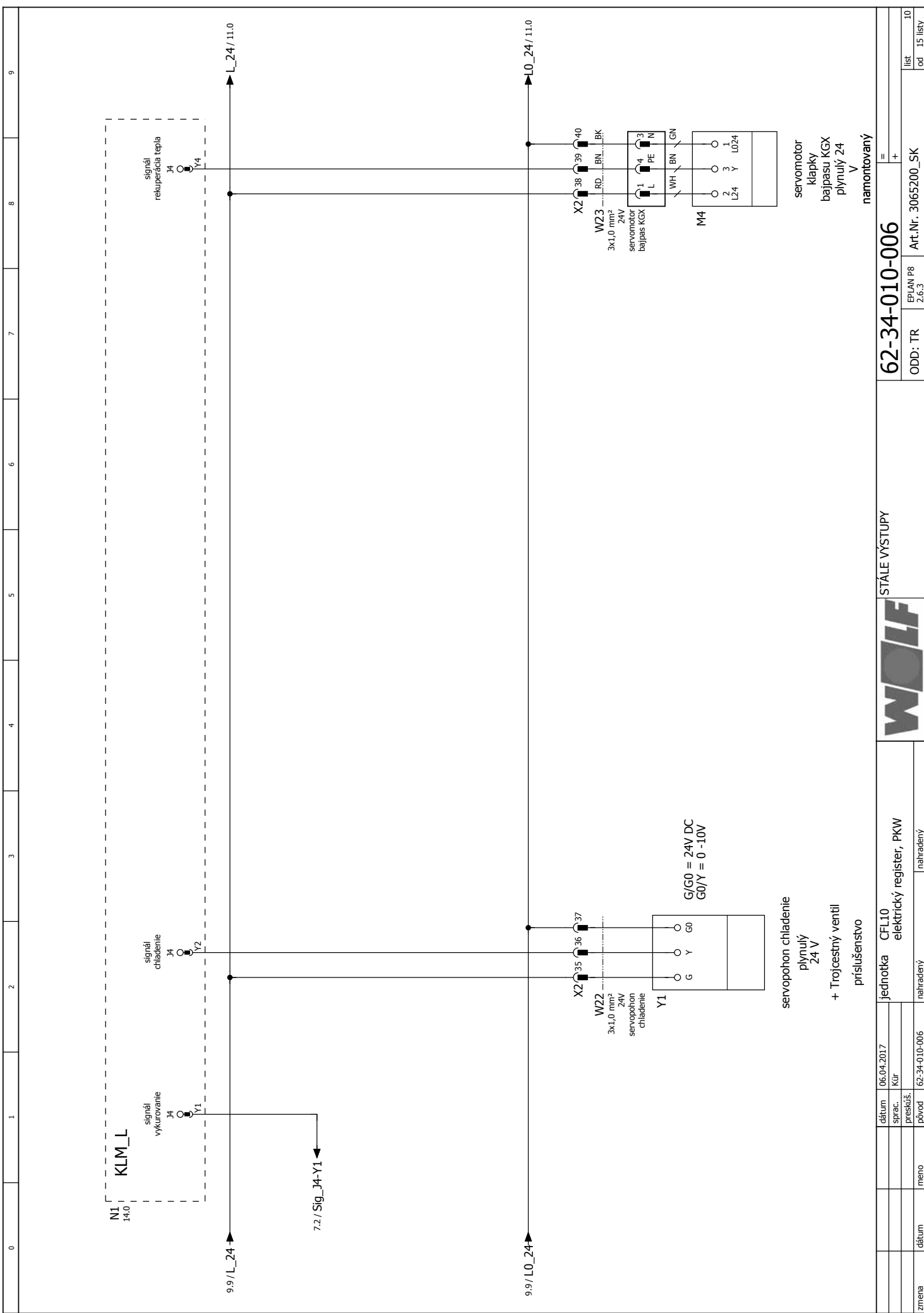

0		1		2		3		4		5		6		7		8		9	
WOLF																			
STALE VÝSTUPY										62-34-010-006									
jedinotka CFL10 elektrický register, PKW										Art.Nr. 3065200_SK									
nahradený										EP/JAN P8 2.6.3									
nahradený										ODD: TR									
nahradený										=									
nahradený										+									
nahradený										servomotor									
nahradený										klapky									
nahradený										bajpasu KGX									
nahradený										plynujú 24 V									
nahradený										namontovaný									
nahradený										list									
nahradený										od									
nahradený										15 listy									

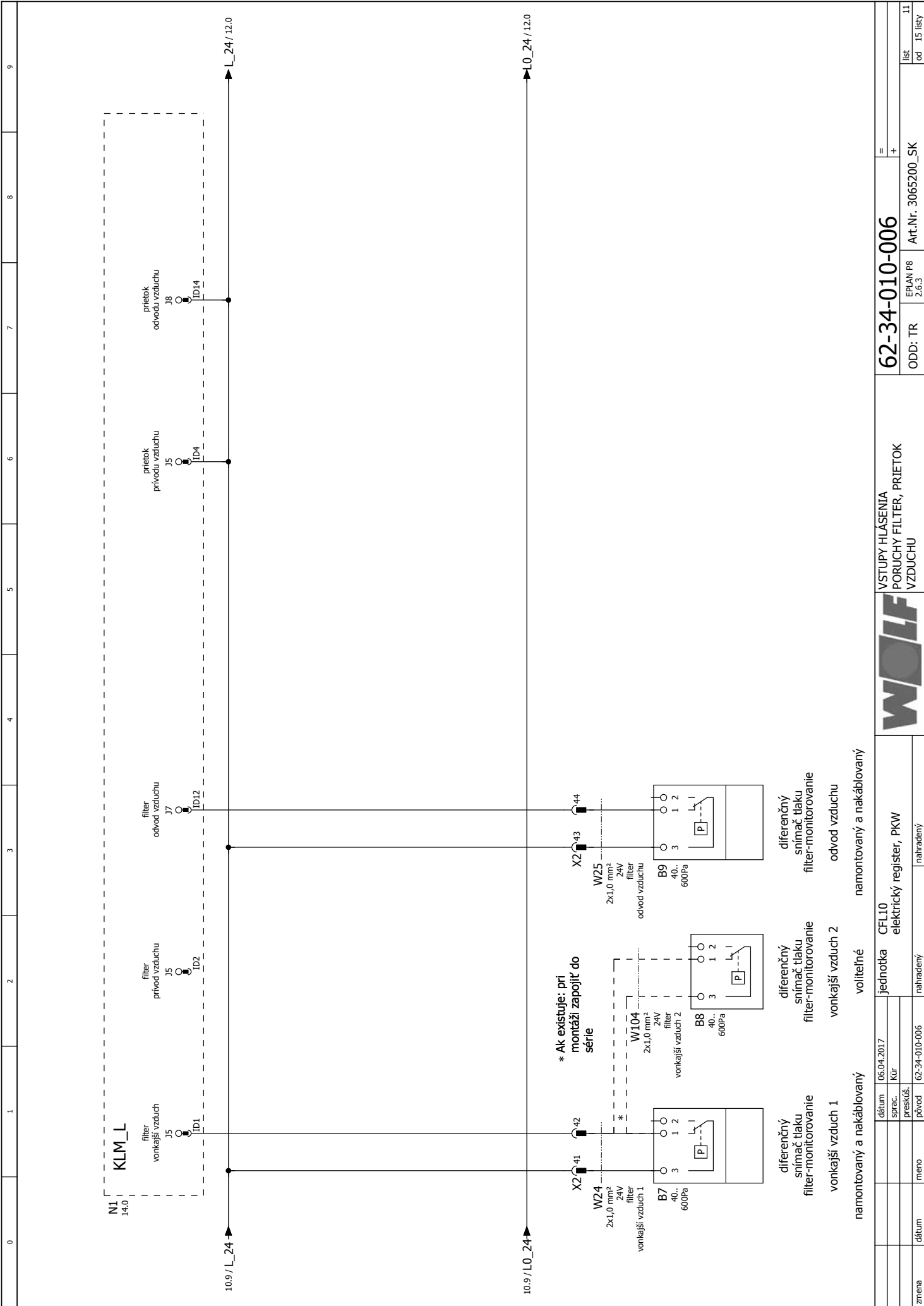

0	1	2	3	4	5	6	7	8	9
---	---	---	---	---	---	---	---	---	---

zmena		dátum	meno	preskúš.	pôvod	náhradný		náhradný	
jednotka		CFL10	elektrický register, PKW	náhradný		náhradný		náhradný	
dátum		06.04.2017	Kür	62-34-010-006		62-34-010-006		62-34-010-006	
námontovaný a nakáblovaný		voliteľné		namontovaný a nakáblovaný		namontovaný a nakáblovaný		namontovaný a nakáblovaný	
VSTUPY HLÁSENIA		PORUCHY FILTER, PRIETOK		VZDUCHU		VZDUCHU		VZDUCHU	
62-34-010-006		EPLAN P8		2.6.3		Art.Nr. 3065200_SK		= +	
ODD: TR		EPLAN P8		2.6.3		Art.Nr. 3065200_SK		= +	
list		od		11		15		11	



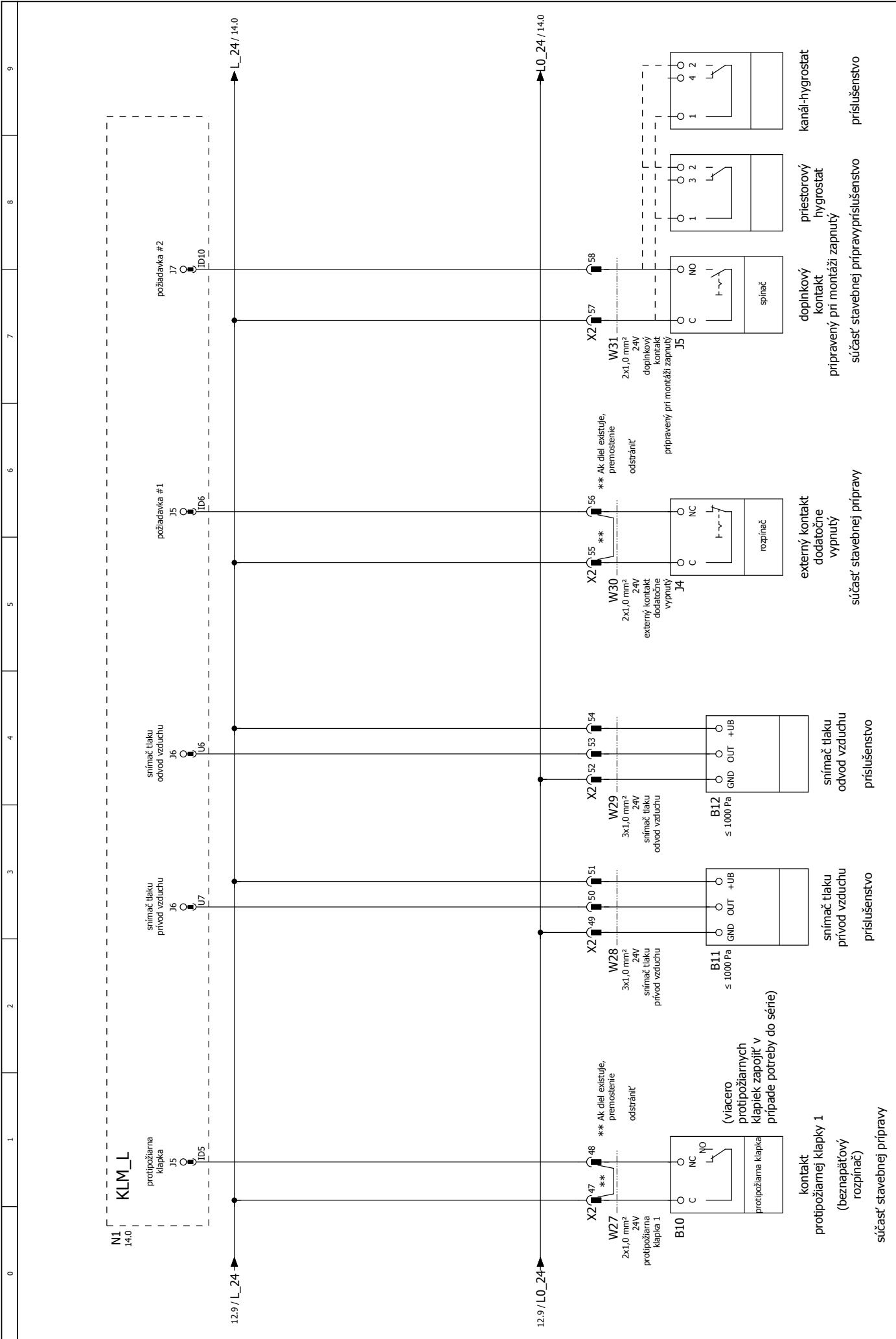

62-34-010-006		= +	
ODD: TR	EPLAN P8 2.6.3	Art.Nr. 3065200_SK	let 13
POŽIAR SNÍMAČ TLAKU HYGROSTAT		príslušenstvo	
zmena	dátum	meno	pôvod
	06.04.2017	Kür	nahradený
jednotka CFL10		elektrický register, PKW	
nahradený		nahradený	



Kabelině sřařas

Iřvardyti kabelų skerspjūviai yra minimalūs pūtvīs vario kabelų neatřvelgiant kabelo ilgīs ir vietas pažeidimais. Kabelų tipai parenkami atsizvelgiant į montavimo tipas. Linijos jutikliai, vožuuvų, servovarikams (24V) neįjuda kartu su 230/400V linijų arba naudoti ekranuotus kabelius.

DĖMESIO: (24V) kabeliai - Gyslų skaičius be žalia-geltona šerdimi

F10_001_Wolf

žymėjimas	Zdroj (od)	Ciel' (up)	dalis įvardijimas	všetky vodiče	Prierez [mm]	napätie	strana
W1	X1	EINSP1-Q1	externė napėjanie	3	1,5	230V	3
W10	X1	M1	čerpadio chladenia	3	1,5	230V	7
W11	X1	M2	servomotor vonkajęši vzduch	4	1,5	230V	7
W12	X1	M3	servomotor odvod vzduchu	4	1,5	230V	7
W13	X1	J1	hlásenie zbernej poruchy	4	1,5	230V	8
W14	X2	A1	Bus LON	3	1,0	24V+Schirm	8
W15	X2	A3	BMK	4	1,0	24V+Schirm	8
W16	X2	B1	snimač teploty privodu vzduchu	2	1,0	24V	9
W17	X2	B2	snimač vonkajęšj teploty	2	1,0	24V	9
W18	X2	B3	snimač priestorovej teploty	2	1,0	24V	9
W22	X2	Y1	servopohon chladenie	3	1,0	24V	10
W27	X2	B10	protipožarna klapka 1	2	1,0	24V	13
W28	X2	B11	snimač tlaku privod vzduchu	3	1,0	24V	13
W29	X2	B12	snimač tlaku odvod vzduchu	3	1,0	24V	13
W30	X2	J4	externý kontakt dodatočne vypnutý	2	1,0	24V	13
W31	X2	J5	doplňkový kontakt pripraveny pri montáži zapnutý	2	1,0	24V	13
W101	N1	J2	požadavka chlad	3	1,5	variabel	8
W102	X2	A2	BMK-F	4	1,0	24V+Schirm	8
W103	X2	J3	doplňkový modul	7	0,227	24V	8
W104	B7	B8	filter vonkajęšj vzduch 2	2	1,0	24V	11

Kabelině sřařas : W1 - W104



CFL10
elektrický register, PKW

jednotka

dátum sprac. 06.04.2017
preškus. KÜR

meno

dátum

zmena

62-34-010-006
nahradeny

nahradeny

nahradeny

62-34-010-006

Art.Nr. 3065200_SK

=

+

list 15
od 15 listy

WOLF GMBH

POSTFACH 1380 / D-84048 MAINBURG / TEL. +49.0. 87 51 74- 0 / FAX +49.0.87 51 74- 16 00

www.WOLF.eu

3065200_201706

Zmeny vyhradené